

Simply Cinema™

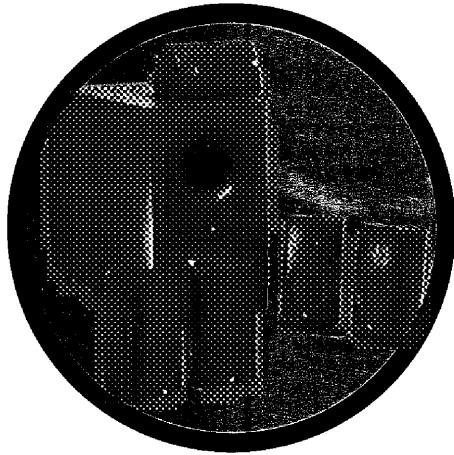

SCS115
simple
set-up guide

thank you for choosing JBL. For over 50 years, JBL has been involved in every aspect of musical and film recording and reproduction, from live performances to monitoring the recordings you play in your home, car, or office.

We're confident that the **JBL system** you have chosen will provide every note of enjoyment that you expected – and that when you think about purchasing additional audio equipment for your home, car, or office, you will once again choose JBL.

Please take a moment to complete the enclosed profile card. It enables us to keep you posted on our latest advancements, and helps us to better understand our customers and build products that meet your needs and expectations.

JBL Consumer Products

read first! Important Safety Precautions!

CAUTION

RISK OF ELECTRIC SHOCK DO NOT OPEN

CAUTION: To prevent electric shock, do not remove the grounding plug on the power cord, or use any plug or extension cord that does not have a grounding plug provided.

Make certain that the AC outlet is properly grounded. Do not use an adapter plug with this product.

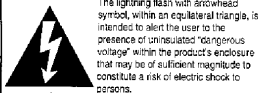

The lightning flash with arrowhead symbol, within an equilateral triangle, is intended to alert the user to the presence of uninsulated "dangerous voltage" within the product's enclosure that may be of sufficient magnitude to constitute a risk of electric shock to persons.



The exclamation point within an equilateral triangle is intended to alert the user to the presence of important operating and maintenance (servicing) instructions in the literature accompanying the appliance.

1. **Read Instructions.** All the safety and operating instructions should be read before the product is operated.
2. **Retain Instructions.** The safety and operating instructions should be retained for future reference.
3. **Heed Warnings.** All warnings on the product and in the operating instructions should be adhered to.
4. **Follow Instructions.** All operating and use instructions should be followed.
5. **Water and Moisture.** The product should not be used near water – for example, near a bathtub, washbowl, kitchen sink, laundry tub, in a wet basement, or near a swimming pool, and the like.
6. **Accessories.** Do not place this product on an unstable cart, stand, tripod, bracket, or table. The product may fall, causing serious injury to a child or adult, and serious damage to the product. Use only with a cart, stand, tripod, bracket, or table recommended by the manufacturer, or sold with the product. Any mounting of the product should follow the manufacturer's instructions, and should use a mounting accessory recommended by the manufacturer.
7. **Wall or Ceiling Mounting.** The product should be mounted on a wall or ceiling only when and as recommended by the manufacturer.
8. **Ventilation.** Slots and openings in the cabinet are provided for ventilation and to ensure reliable operation of the product and to protect it from overheating, and these openings must not be blocked or covered. The openings should never be blocked by

- placing the product on a bed, sofa, rug, or other similar surface. This product should not be placed in a built-in installation such as a bookcase or rack unless proper ventilation is provided or the manufacturer's instructions have been adhered to.
9. **Heat.** The product should be situated away from heat sources such as radiators, heat registers, stoves, or other products that produce heat. If placed near an amplifier, check with the manufacturer for applicability.
 10. **Power Sources.** This product should be operated only from the type of power source indicated on the marking label. If you are not sure of the type of power supply to your home, consult your product dealer or local power company. For products intended to operate from battery power, or other sources, refer to the operating instructions.
 11. **Grounding or Polarization.** This product may be equipped with a polarized alternating-current line plug (a plug having one blade wider than the other). This plug will fit into the power outlet only one way. This is a safety feature. If you are unable to insert the plug fully into the outlet, try reversing the plug. If the plug should still fail to fit, contact your electrician to replace your obsolete outlet. Do not defeat the safety purpose of the polarized plug.
 12. **Power-Cord Protection.** Power-supply cords should be routed so that they are not likely to be walked on or pinched by items placed upon or against them, paying particular attention to cords at plugs, convenience receptacles, and the point where they exit from the product.
 13. **Cleaning.** Unplug this product from the wall outlet before cleaning. Do not use liquid cleaners or aerosol cleaners. Use a damp cloth for cleaning.
 14. **Nonuse Periods.** The power cord of the product should be unplugged from the outlet when left unused for long periods of time.
 15. **Lightning.** For added protection for this product during a lightning storm, or when it is left unattended and unused for long periods of time, unplug it from the wall outlet and disconnect the antenna or cable system. This will prevent damage to the product due to lightning and power-line surges.
 16. **Overloading.** Do not overload wall outlets, extension cords, or inte-

- gral convenience receptacles, as this can result in a risk of fire or electric shock.
17. **Object and Liquid Entry.** Never push objects of any kind into this product through openings, as they may touch dangerous voltage points or short-out parts that could result in a fire or electric shock. Never spill liquid of any kind on the product.
 18. **Damage Requiring Service.** Unplug this product from the wall outlet and refer servicing to qualified service personnel under the following conditions:
 - a. The power-supply cord or the plug has been damaged; or
 - b. Objects have fallen, or liquid has been spilled into the product; or
 - c. The product has been exposed to rain or water; or
 - d. The product does not operate normally when following the operating instructions. Adjust only those controls that are covered by the operating instructions, as an improper adjustment of other controls may result in damage and will often require extensive work by a qualified technician to restore the product to its normal operation; or
 - e. The product has been dropped, or the enclosure damaged; or
 - f. The product does not appear to operate normally or exhibits a marked change in performance.
 19. **Attachments.** Do not use attachments not recommended by the product manufacturer, as they may cause hazards.
 20. **Replacement Parts.** When replacement parts are required, be sure the service technician has used replacement parts specified by the manufacturer or that have the same characteristics as the original part. Unauthorized substitutions may result in fire, electric shock or other hazards.
 21. **Safety Check.** Upon completion of any service or repairs to this product, ask the service technician to perform safety checks to determine that the product is in proper operating condition.
 22. **Servicing.** Do not attempt to service this product yourself, as opening or removing covers may expose you to dangerous voltage or other hazards. Refer all servicing to qualified service personnel.

included

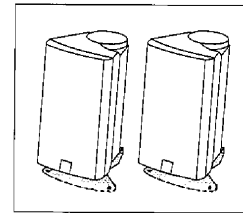

Two satellite speakers (with removable shelf stands).

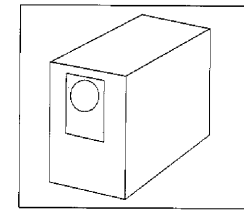

One 100-watt powered subwoofer.

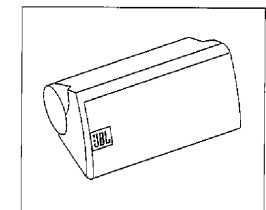

One sat10 center speaker.

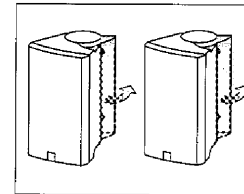

One pair of sat10 surround speakers with removable wall-mounting brackets.

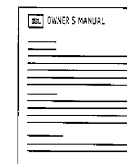

Owner's manual.



Survey card.

features

- 2-way satellite speakers with 3/4" titanium composite dome high-frequency drivers
- 100-watt powered bass reflex subwoofer
- Adjustable satellites with shelf stands included
- Adjustable, removable wall-mounting brackets (for use with surround speakers)
- Video-shielded satellites
- Recessed wire channels on satellites and surrounds
- Diffraction-limiting foam satellite baffles

one. Speaker Placement

Satellites

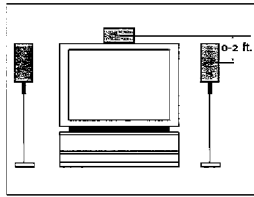
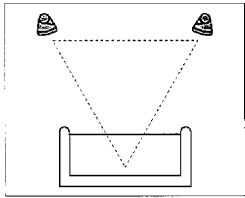

Subwoofer

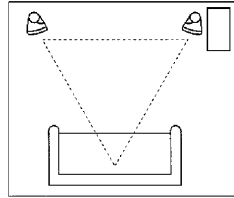

Surround Speakers

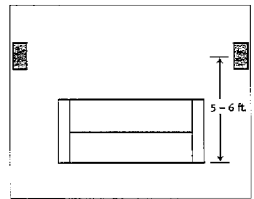
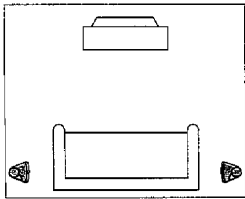

Mounting Options

Satellites

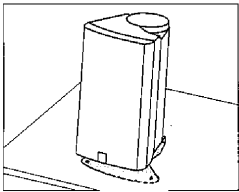

On shelves.

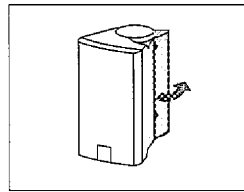

On the wall. Optional bracket.
Part No. SFX10BKT, or
SFX10BKTWHT (white).

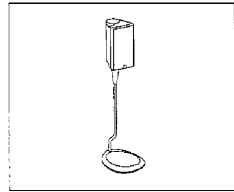

On optional stands.
Part No. FS10/20.
FS10/20WHT (white).

Surrounds

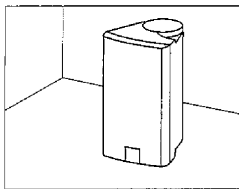

On shelves.

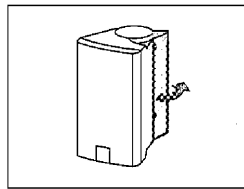

Wall-mounted. Brackets and
hardware included.

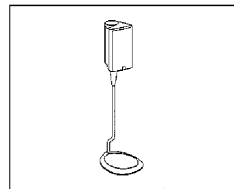

On optional stands.

two. Speaker Connections

Connection Tips

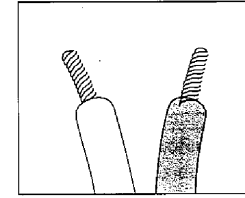
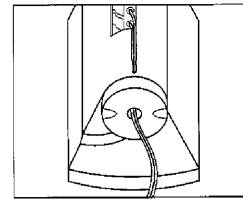

For satellites, thread speaker wire through the hole in the bottom of the speaker, then feed it through the recessed wire channel.

Separate and strip the ends of the speaker wire as shown. Speakers and electronics terminals have corresponding (+) and (-) terminals. It is important to connect both speakers

identically: (+) on the speaker to (+) on the amplifier and (-) on the speaker to (-) on the amplifier. Wiring "out of phase" results in thin sound, weak bass and a poor stereo image.

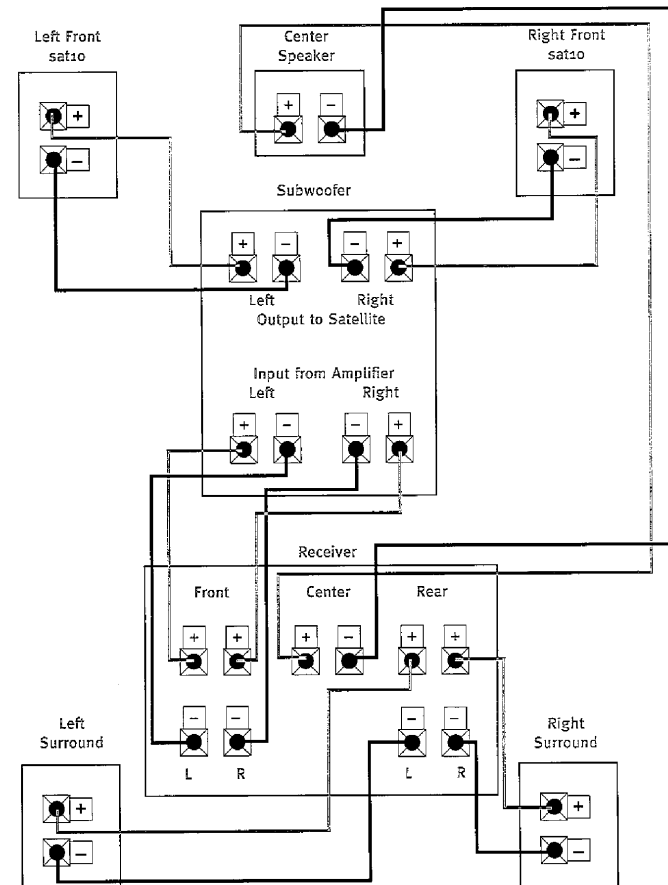

three. Operation

Power

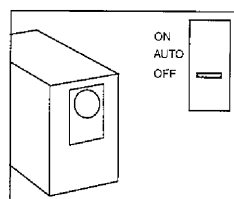
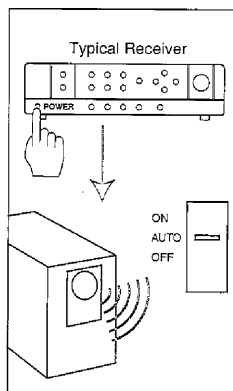
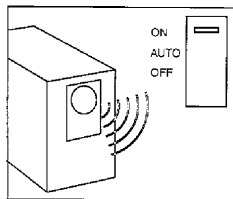

Volume

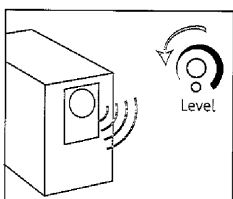
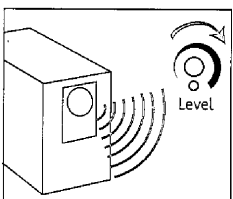

Troubleshooting

If there is no sound from any of the speakers, check the following:

- Receiver/amplifier is on and a source is playing.
- Powered subwoofer is plugged in and is either in the "On" or "Auto" position.

- Check all wires and connections between receiver/amplifier and speakers. Make sure all wires are connected. Make sure none of the speaker wires are frayed, cut, or punctured.
- Review proper operation of your receiver/amplifier.

If there is no sound coming from one speaker, check the following:

- Check the "Balance" control on your receiver/amplifier.
- Check all wires and connections between receiver/amplifier and speakers. Make sure all wires are connected. Make sure none of the speaker wires are frayed, cut, or punctured.

If the system plays at low volumes but shuts off as volume is increased, check the following:

- Check all wires and connections between receiver/amplifier and speakers. Make sure all wires are connected. Make sure none of the speaker wires are frayed, cut, or punctured.
- If more than one pair of main speakers is being used, check the minimum impedance requirements of your receiver/amplifier.

If there is low bass output, check the following:

- Make sure the connections to the left and right "Speaker Inputs" have the correct polarity (+ and -).
- Make sure that the subwoofer is plugged into an active electrical outlet.
- Powered subwoofer is plugged in and is either in the "On" or "Auto" position.

If there is no sound from the surround speakers, check the following:

- Check all wires and connections between receiver/amplifier and speakers. Make sure all wires are connected. Make sure none of the speaker wires are frayed, cut, or punctured.
- Review proper operation of your receiver/amplifier and its surround sound features.
- Make sure the movie or TV show, you are watching is recorded in Dolby* surround. If it is not, check to see if your receiver/amplifier has other surround modes you may use.

Specifications

SCS115 System

Frequency Response
40Hz - 20kHz (±3dB)

sat10

Recommended Power
10 - 80 watts

Frequency Response
150Hz - 20kHz (±3dB)

Impedance
8 ohms nominal

Sensitivity
88dB @ 1 watt/1 meter

Crossover Frequency
3.5kHz (midrange to tweeter)

Tweeter
One 3/4" titanium composite dome, video-shielded

Midrange
One 3-1/2" neodymium driver, video-shielded

Dimensions (HxWxD)
6-1/2 x 3-3/4 x 4-1/4 inches
165 x 95 x 108mm

Weight
1.5 lbs/.7 kg

sat10 Surround

Recommended Power
10 - 70 watts

Impedance
8 ohms nominal

Sensitivity
90dB @ 1 watt/1 meter

Frequency Response
100Hz - 15kHz (±3dB)

Dimensions (HxWxD)
6-1/2 x 3-3/4 x 4-1/4 inches
165 x 95 x 108mm

Weight
1.5 lbs/.7 kg

bass15

Amplifier
100 watts RMS

Frequency Response
40Hz - 150Hz (±3dB)

Sensitivity
88dB @ 1 watt/1 meter

Crossover Frequency
150Hz (subwoofer to satellite)

Bass
Two 5-1/4" woofers, triple chamber band-pass enclosure

Dimensions (HxWxD)
14-3/4 x 8-1/2 x 19-3/4 inches
375 x 216 x 502mm

Weight
35 lbs/15.9 kg